



MICROWAVE OVEN

M633

SERVICE Manual

MICROWAVE OVEN

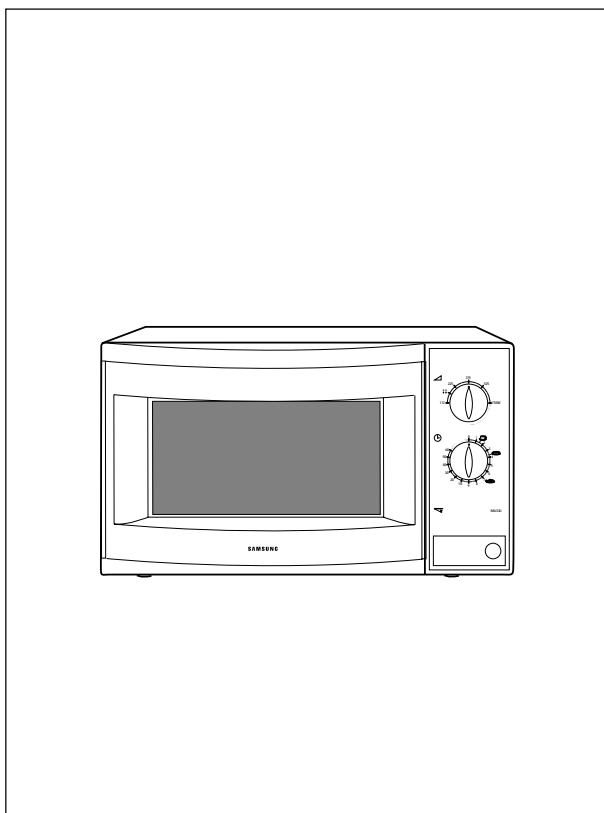

SEHK

CONTENTS

1. Precaution
2. Statements
3. Operating Instructions
4. Disassembly and Reassembly
5. Alignment and Adjustments
6. Troubleshooting
7. Exploded Views and Parts List
8. Wiring Diagrams

1. Precaution

Follow these special safety precautions. Although the microwave oven is completely safe during ordinary use, repair work can be extremely hazardous due to possible exposure to microwave radiation, as well as potentially lethal high voltages and currents.

1-1 Safety precautions (⚠)

1. All repairs should be done in accordance with the procedures described in this manual. This product complies with Federal Performance Standard 21 CFR Subchapter J (DHHS).
2. Microwave emission check should be performed prior to servicing if the oven is operative.
3. If the oven operates with the door open : Instruct the user not to operate the oven and contact the manufacturer and the center for devices and radiological health immediately.
4. Notify the Central Service Center if the microwave leakage exceeds 5 mW/cm²
5. Check all grounds.
6. Do not power the MWO from a "2-prong" AC cord. Be sure that all of the built-in protective devices are replaced. Restore any missing protective shields.
7. When reinstalling the chassis and its assemblies, be sure to restore all protective devices, including: nonmetallic control knobs and compartment covers.
8. Make sure that there are no cabinet openings through which people--particularly children--might insert objects and contact dangerous voltages. Examples: Lamp hole, ventilation slots.
9. Inform the manufacturer of any oven found to have emission in excess of 5 mW/cm², Make repairs to bring the unit into compliance at no cost to owner and try to determine cause.
Instruct owner not to use oven until it has been brought into compliance.
10. Service technicians should remove their watches while repairing an MWO.
11. To avoid any possible radiation hazard, replace parts in accordance with the wiring diagram. Also, use only the exact replacements for the following parts: Primary and secondary interlock switches, interlock monitor switch.
12. If the fuse is blown by the Interlock Monitor Switch: Replace all of the following at the same time: Primary, door sensing switch and power relay, as well as the Interlock Monitor Switch. The correct adjustment of these switches is described elsewhere in this manual. Make sure that the fuse has the correct rating for the particular model being repaired.
13. Design Alteration Warning:
Use exact replacement parts only, i.e., only those that are specified in the drawings and parts lists of this manual. This is especially important for the Interlock switches, described above. Never alter or add to the mechanical or electrical design of the MWO. Any design changes or additions will void the manufacturer's warranty.10.Always unplug the unit's AC power cord from the AC power source before attempting to remove or reinstall any component or assembly.
14. Never defeat any of the B+ voltage interlocks. Do not apply AC power to the unit (or any of its assemblies) unless all solid-state heat sinks are correctly installed.
15. Some semiconductor ("solid state") devices are easily damaged by static electricity. Such components are called Electrostatically Sensitive Devices (ESDs). Examples include integrated circuits and field-effect transistors.

Immediately before handling any semiconductor components or assemblies, drain the electrostatic charge from your body by touching a known earth ground.
16. Always connect a test instrument's ground lead to the instrument chassis ground *before* connecting the positive lead; always remove the instrument's ground lead last.

CENTRAL SERVICE CENTER

1-2 Special Servicing Precautions (Continued)

17. When checking the continuity of the witches or transformer, always make sure that the power is OFF, and one of the lead wires is disconnected.
18. Components that are critical for safety are indicated in the circuit diagram by shading, ▲ or ▲.
19. Use replacement components that have the same ratings, especially for flame resistance and dielectric strength specifications. A replacement part that does not have the same safety characteristics as the original might create shock, fire or other hazards.

1-3 Special High Voltage Precautions

1. High Voltage Warning
Do not attempt to measure any of the high voltages--this includes the filament voltage of the magnetron. High voltage is present during any cook cycle.

Before touching any components or wiring, always unplug the oven and discharge the high voltage capacitor (See Figure 1-1)
2. The high-voltage capacitor remains charged about 30 seconds after disconnection. Short the negative terminal of the high-voltage capacitor to the oven chassis. (Use a screwdriver.)
3. High voltage is maintained within specified limits by close-tolerance, safety-related components and adjustments. If the high voltage exceeds the specified limits, check each of the special components.

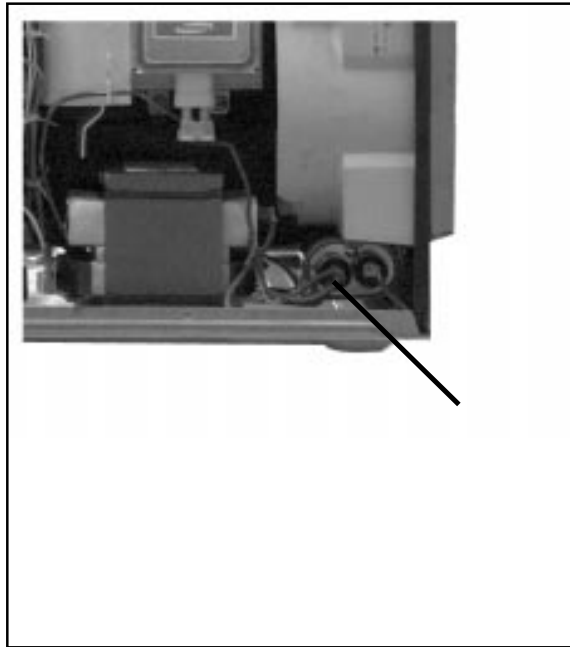

Fig. 1-1. Discharging the High Voltage Capacitor

2. Specifications

2-1 Table of Specifications

	M633
POWER SOURCE	230V 50Hz, AC
POWER CONSUMPTION	1300W
OUTPUT POWER	FROM 112W TO 750W (6 LEVEL POWER) (IEC-705 TEST PROCEDURE)
OPERATING FREQUENCY	2450MHz
TIMER	60 MINUTES
COOLING METHOD	COOLING FAN MOTOR
MAGNETRON	OM75S(31)
OUTSIDE DIMENSIONS	489(W) x 275(H) x 351(D)mm
SHIPPING WEIGHT	APPROX. 14.5 Kg

3. Operating Instructions

3-1 Control Panel

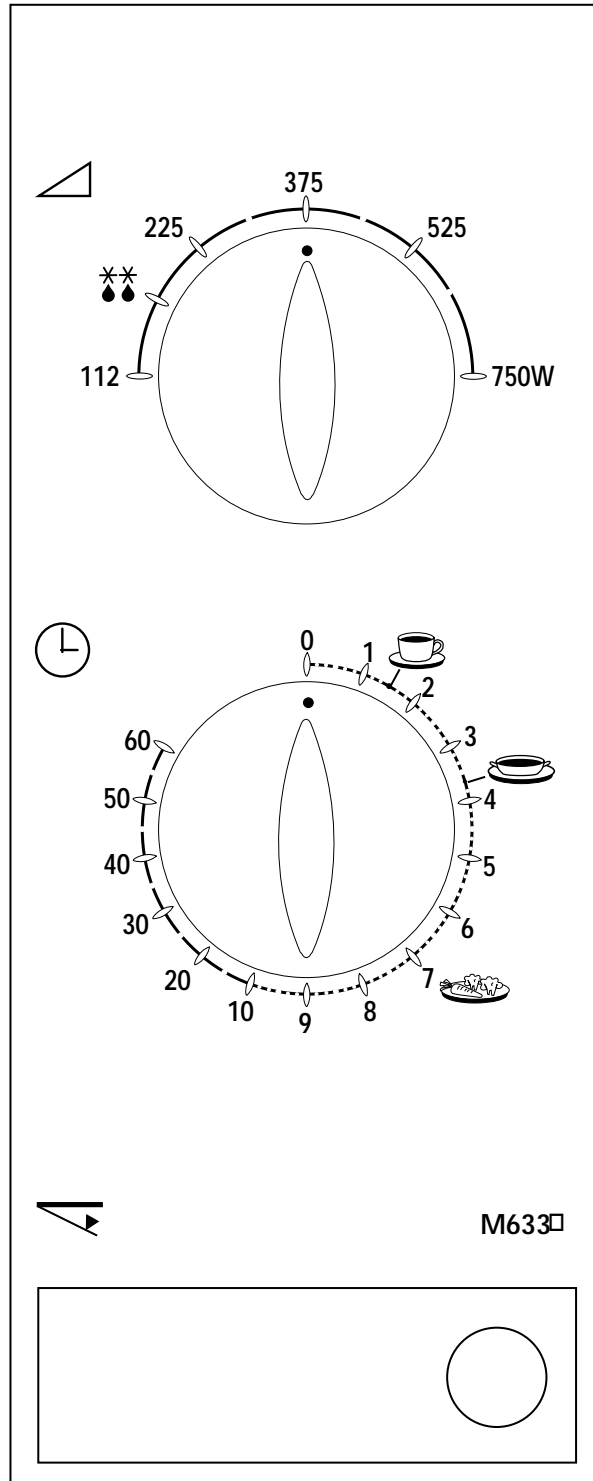

3-2 Features & External Views

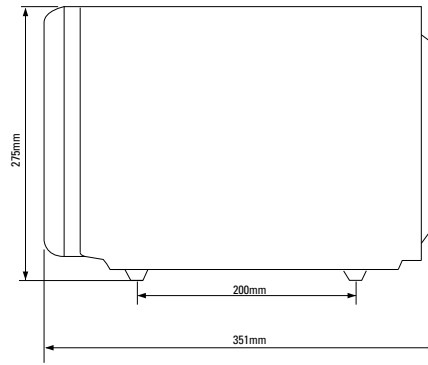
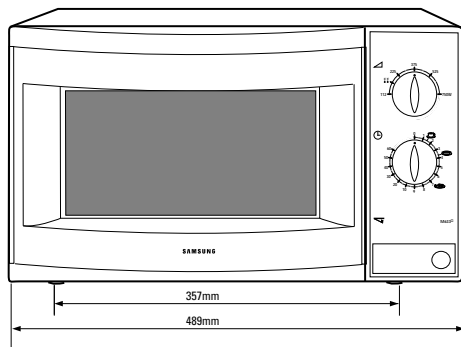
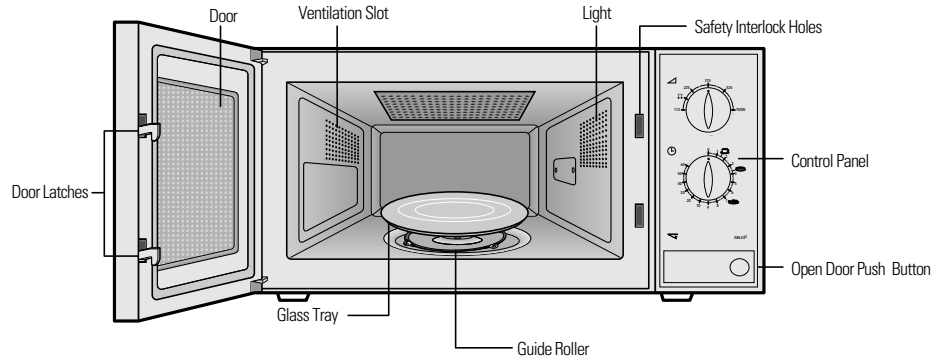

3-3 Checking That Your Oven is Operating Correctly

NOTE: The oven must be plugged into an appropriate wall socket.

The glass plate must be in position in the oven.

1. Open the oven door by pushing the OPEN DOOR button. Place a glass of water on the glass plate. Close the door.
2. Set the power level to 100(maximum) by turning COOKING POWER CONTROL knob.
3. Set the time to 4 to 5 minutes by turning TIMER knob.

Important: If any problem is experienced in the operation of the oven, please refer to the section on page 4 "what to do if you are in doubt or have a problem."

3-4 Variable Power Cooking Chart

Operation:

Set the COOKING POWER CONTROL knob to the appropriate power level by turning it.

POWER LEVEL	%	OUTPUT
		M633
HIGH	100%	750W
MEDIUM HIGH	70%	525W
MEDIUM	50%	375W
LOW	30%	225W
DEFROST	20%	150W
WARM	15%	112W

3-5 Adjusting the Cooking Time During Cooking

Stopping the Cooking

To stop the cooking....	Press....
Temporarily	Open Door. To resume cooking, close the door.
Completely	Turn the TIMER knob to '0'

Adding Extra Time

Simply move the timer knob to any increased setting that you require.

3-6 Manual Defrosting Food

1. Place the frozen food in the oven and close the door.
2. Turn the COOKING POWER CONTROL knob to Defrost symbol.
3. Turn the TIMER knob to select appropriate time.

Result: Defrosting begins.

When Defrosting has finished, the oven beeps.

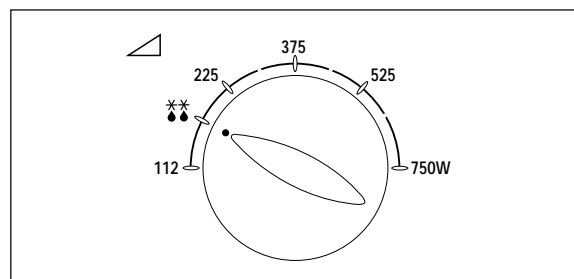

3-7 Instant Cook Guide

1. Place the food in the oven and close the door.
2. Turn the COOKING POWER CONTROL knob to Max Power.
3. Turn the TIMER knob to select instant cook, drinks or jacket potatoes.

Symbol	Recipes	Serving Size	Power level	Standing Time
	Drink	150 mL	100%	2~3mins.
	Soup/ Sauce	200~300 ml	100%	2~3mins.
	Fresh Vegetables	200~300 g	100%	2~3mins

4. Disassembly & Reassembly

4-1 Replacement of Magnetron, Motor Assembly and Lamp

Remove the magnetron including the shield case, permanent magnet, choke coils and capacitors (all of which are contained in one assembly).

1. Disconnect all lead wires from the magnetron and lamp.
2. Remove a screw securing the magnetron supporter.
3. Remove the magnetron supporter.
4. Remove the air cover.
5. Remove screws securing the magnetron to the wave guide.
6. Take out the magnetron very carefully.
7. Remove screws from the back panel.
8. Take out the fan motor.
9. Remove the oven lamp by rotating to pull out from hole of air cover.

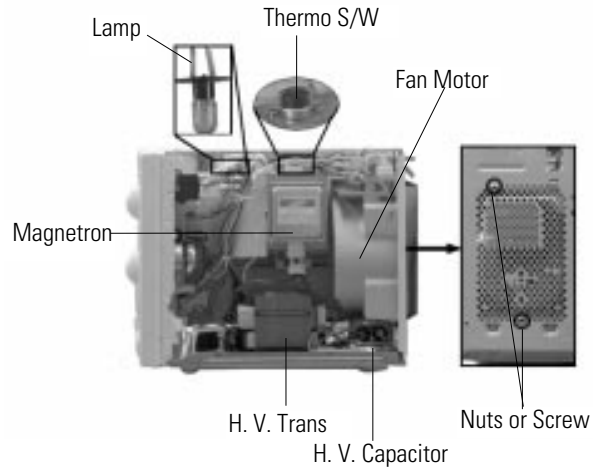

NOTE1: When removing the magnetron, make sure that its antenna does not hit any adjacent parts, or it may be damaged.

NOTE2: When replacing the magnetron, be sure to remount the magnetron gasket in the correct position and make sure the gasket is in good condition.

4-2 Replacement of High Voltage Transformer

1. Discharge the high voltage capacitor.
2. Disconnect all the leads.
3. Remove the mounting bolts.
4. Reconnect the leads correctly and firmly.

PRECAUTION

There exists HIGH VOLTAGE ELECTRICITY with high current capabilities in the circuits of the HIGH VOLTAGE TRANSFORMER secondary and filament terminals. It is extremely dangerous to work on or near these circuits with the oven energized.

DO NOT measure the voltage in the high voltage circuit including filament voltage of magnetron.

PRECAUTION

Never touch any circuit wiring with your hand nor with an insulated tool during operation.

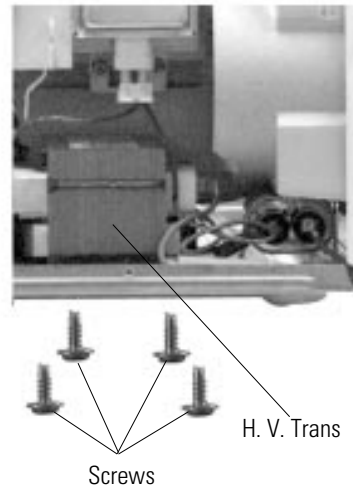

P-HVT

4-3 Replacement of Door Assembly

4-3-1 Removal of Door Assembly

Remove hex bolts securing the upper hinge and lower hinge. Then remove the door assembly.

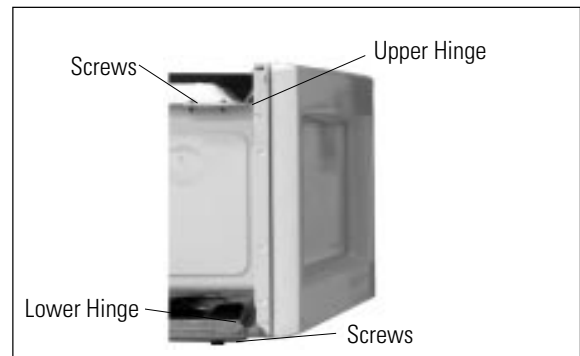

4-3-2 Removal of Door "C"

Insert flat screwdriver into the gap between Door "E" and Door "C" to remove Door "C". Be careful when handling Door "C" because it is fragile.



4-3-3 Removal of Door "E"

Following the procedure as shown in the figure, insert and bend a thin metal plate between Door "E" and Door "A" until you hear the 'tick' sound.

1. Insertion depth of the thin metal plate should be 0.5mm or less.

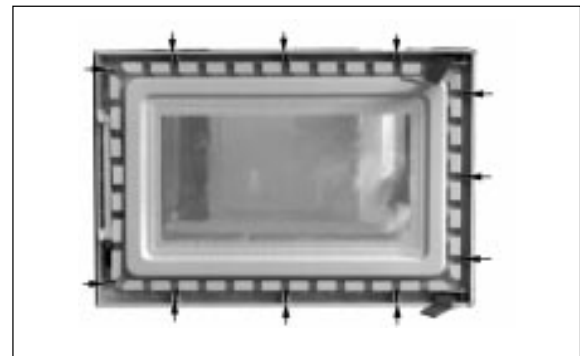

4-3-4 Removal of Key Door & Spring

Remove pin hinge from Door "E"
Detach spring from Door "E" and key door.

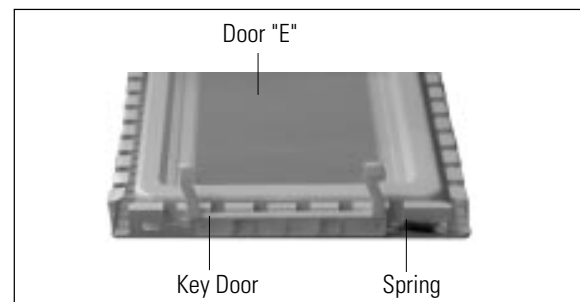

4-3-5 Reassembly Test

After replacement of the defective component parts of the door, reassemble it and follow the instructions below for proper installation and adjustment so as to prevent an excessive microwave leakage.

1. When mounting the door to the oven, be sure to adjust the door parallel to the bottom line of the oven face plate by moving the upper hinge and lower hinge in the direction necessary for proper alignment.
2. Adjust so that the door has no play between the inner door surface and oven front surface. If the door assembly is not mounted properly, microwave energy may leak from the space between the door and oven.
3. Do the microwave leakage test.

4-4 Replacement of Fuse

1. Disconnect the oven from the power source.
2. When 15A fuse blows out by the operation of interlock monitor switch failure, replace the primary interlock switch, door sensing switch, monitor switch and power relay.
3. When the above three switches operate properly, check if any other part such as the control circuit board, blower motor or high voltage transformer is defective.

4-5 Replacement of Drive Motor

1. Disconnect the oven from the power source.
2. Remove the 10A fuse in the fuse holder.
3. When replacing the 10A fuse, be sure to use an exact replacement part. If new 10A fuse blows out again after replacement, check the primary interlock switch, door sensing switch and interlock monitor switch.
4. When the above three switches operate properly, check if any other part such as the control circuit board, blower motor or high voltage transformer is defective.

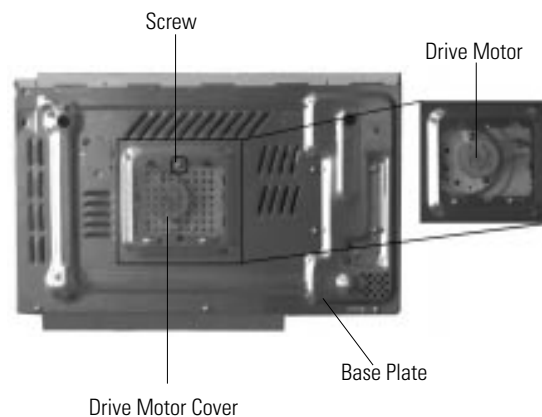

5. Alignment and Adjustments

PRECAUTION

1. High voltage is present at the high voltage terminal of the high voltage transformer during any cook cycle.
2. It is neither necessary nor advisable to attempt measurement of the high voltage.
3. Before touching any oven components, or wiring, always unplug the oven from its power source and discharge the high voltage capacitor.

5-1 High Voltage Transformer

1. Remove connectors from the transformer terminals and check continuity.
2. Normal resistance readings should be as follows:
SecondaryApprox. 131.5 Ω
FilamentApprox. 0 Ω
Primary.....Approx. 2.29 Ω
(Room temperature = 20°C)

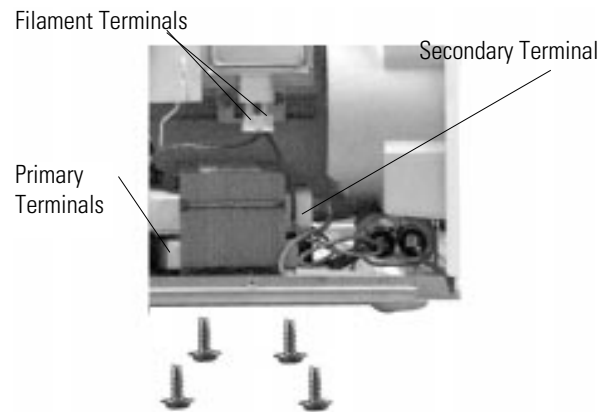

5-2 Magnetron

1. Continuity checks can only indicate an open filament or a shorted magnetron. To diagnose an open filament or shorted magnetron.
2. Isolate the magnetron from the circuit by disconnecting its leads.
3. A continuity check across the magnetron filament terminals should indicate one ohm or less.
4. A continuity check between each filament terminal and the magnetron case should read "open".

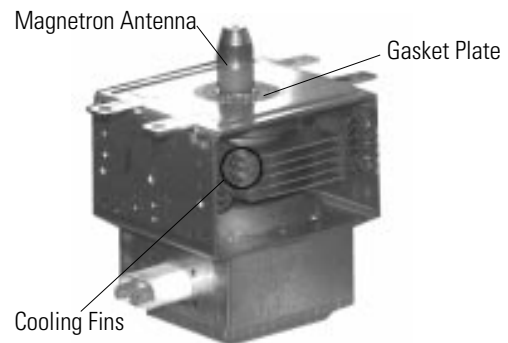

5-3 High Voltage Capacitor

1. Check continuity of the capacitor with meter set at the highest ohm scale.
2. Once the capacitor is charged, a normal capacitor shows continuity for a short time, and then indicates 10MΩ.
3. A shorted capacitor will show continuous continuity.
4. An open capacitor will show constant 10MΩ.
5. Resistance between each terminal and chassis should read infinite.

5-4 High Voltage Diode

1. Isolate the diode from the circuit by disconnecting its leads.
2. With the ohm-meter set at the highest resistance scale, measure the resistance across the diode terminals. Reverse the meter leads and read the resistance. A meter with 6V, 9V or higher voltage batteries should be used to check the front-to back resistance of the diode, otherwise an infinite resistance may be read in both directions. The resistance of a normal diode will be infinite in one direction and several hundred KΩ in the other direction.

5-5 Adjustment of Primary Switch, Door Sensing Switch and Monitor Switch

Precaution

For continued protection against radiation hazard, replace parts in accordance with the wiring diagram and be sure to use the correct part number for the following switches.: Primary and secondary interlock switches and the interlock monitor switch all together. Then follow the adjustment procedures below. After repair and adjustment, be sure to check the continuity of all interlock switches and the interlock monitor switch.

1. When mounting Primary switch and Interlock Monitor switch to Latch Body, consult the figure below.
2. NOTE: No specific adjustment during installation of Primary switch and Monitor switch to the latch body is necessary.
3. When mounting the Latch Body to the oven assembly, adjust to the Latch Body by moving it so that the oven door will not have any play. Check for play in the door by pulling the door assembly. Make sure that the latch keys move smoothly after adjustment is completed. Completely tighten the screws holding the Latch Body to the oven assembly.
4. Reconnect to Monitor switch and check the continuity of the monitor circuit and all latch switches again by following the components test procedures.
5. Confirm that the gap between the switch housing and the switch actuator is no more than 0.5mm when door is closed.

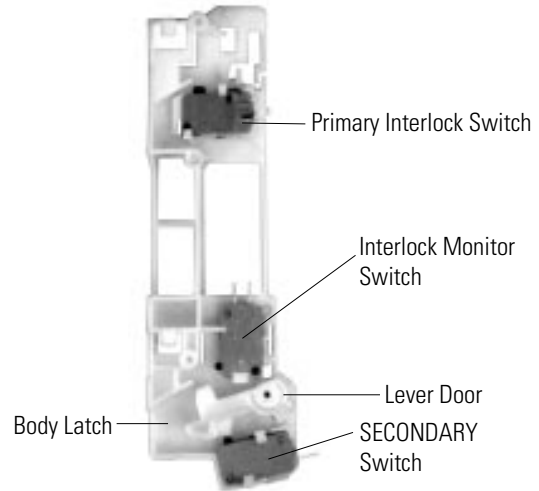

	Door Open	Door Closed
Primary switch	∞	0
Monitor switch (COM-NC)	0	∞
Door Sensing S/W	∞	0
Secondary switch	∞	0

5-6 Output Power of Magnetron

CAUTION MICROWAVE RADIATION

PERSONNEL SHOULD NOT ALLOW EXPOSURE TO MICROWAVE RADIATION FROM MICROWAVE GENERATOR OR OTHER PARTS CONDUCTING MICROWAVE ENERGY.

The output power of the magnetron can be measured by performing a water temperature rise test.

Equipment needed

* Two 1-liter cylindrical borosilicate glass vessel (Outside diameter of 190mm)

* One glass thermometer with mercury column

NOTE : Check line voltage under load. Low voltage will lower the magnetron output. Make all temperature and time tests with accurate equipment.

1. Fill the one liter glass vessel with one liter of water.
2. Stir water in glass vessel with thermometer and record glass vessel's temperature as T1. (10±1°C)
3. After moving the water into another glass vessel, place it on the center of the cooking tray. Set the oven to high power and operate for 52.3 seconds exactly. (2 seconds included as a holding time of magnetron oscillation)
4. When heating is finished, stir the water again with the thermometer and measure the temperature rise as T2.
5. Subtract T1 from T2. This will give you the water temperature rise. (ΔT)
6. The output power is obtained by the following formula;

$$\text{Output Power} = \frac{4.187 \times 1000 \times \Delta T}{52.3}$$

52.3 : Heating Time (sec) * **Output (W) = 100 x ΔT**
 4.187 : Coefficient for Water
 1000 : Water (cc)
 ΔT : Temperature Rise (T2-T1)

7. Normal temperature rise for this model is 9°C to 11°C at 'HIGH'.

NOTE 1: Variations or errors in the test procedure will cause a variance in the temperature rise. Additional power test should be made if temperature rise is marginal.

NOTE 2: Output power in watts is computed by multiplying the temperature rise (step E) by a power factor of 91 in case of centigrade temperature.

5-7 Microwave Heat Distribution - Heat Evenness

The microwave heat distribution can be checked indirectly by measuring the water temperature risen at certain positions in the oven :

1. Prepare five beakers made of 'Pyrex', having 100 milliliters capacity each.
2. Measure exactly 100 milliliters of water load with a measuring cylinder and pour it into each beaker.
3. Measure the temperature of each water load. (Readings shall be taken to the first place of decimals.)
4. Put each beaker in place on the cooking tray as illustrated in figure below and start heating.
5. After heating for 2 minutes, measure the temperatures of water in each beaker.
6. Microwave heat distribution rate can be calculated as follows :

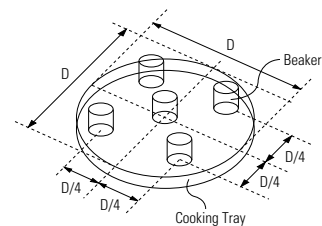

$$\text{Heat Distribution} = \frac{\text{Minimum Temperature Rise}}{\text{Maximum Temperature Rise}} \times 100(\%)$$

The result should exceed 65%.

5-8 Procedure for Measurement of Microwave Energy Leakage

- 1) Pour 275 ± 15 cc of $20 \pm 5^\circ\text{C}$ ($68 \pm 9^\circ\text{F}$) water in a beaker which is graduated to 600cc, and place the beaker in the center of the oven.
- 2) Start to operate the oven and measure the leakage by using a microwave energy survey meter.
- 3) Set survey meter with dual ranges to 2,450MHz.
- 4) When measuring the leakage, always use the 2 inch spacer cone with the probe. Hold the probe perpendicular to the cabinet door. Place the spacer cone of the probe on the door and/or cabinet door seam and move along the seam, the door viewing window and the exhaust openings moving the probe in a clockwise direction at a rate of 1 inch/sec. If the leakage testing of the cabinet door seam is taken near a corner of the door, keep the probe perpendicular to the areas making sure that the probe end at the base of the cone does not get closer than 5cm to any metal. If it gets closer than 5cm, erroneous readings may result.
- 5) Measured leakage must be less than $4\text{mW}/\text{cm}^2$, after repair or adjustment.

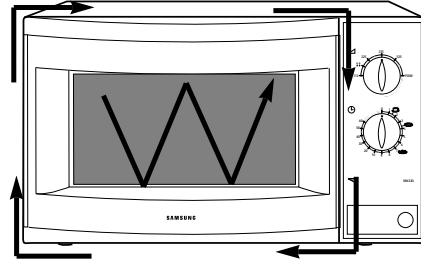

Maximum allowable leakage is $5\text{mW}/\text{cm}^2$.
 $4\text{mW}/\text{cm}^2$ is used to allow for measurement and meter accuracy

5-9 Check for Microwave Leakage

1. Remove the outer panel.
2. Pour 275 ± 15 cc of $20 \pm 5^\circ\text{C}$ ($68 \pm 9^\circ\text{F}$) water in a beaker which is graduated to 600cc, and place the beaker in the center of the oven.
3. Start the oven at the highest power level.
4. Set survey meter dual ranges to 2,450MHz.
5. Using the survey meter and spacer cone as described above, measure around the opening of magnetron, the surface of the air guide and the surface of the wave guide as shown in the following photo. (but avoid the high voltage components.) The reading should be less than $4\text{mW}/\text{cm}^2$.

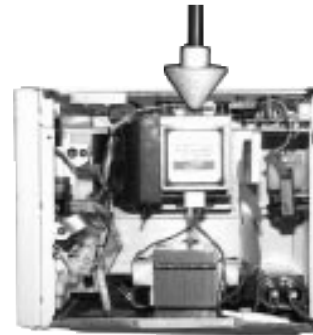

5-10 Note on Measurement

- 1) Do not exceed the limited scale.
- 2) The test probe must be held on the grip of the handle, otherwise a false reading may result when the operator's hand is between the handle and the probe.
- 3) When high leakage is suspected, do not move the probe horizontally along the oven surface; this may cause damage to the probe.
- 4) Follow the recommendation of the manufacturer of the microwave energy survey meter.

5-11 Leakage Measuring Procedure

5-11-1 Record keeping and notification after measurement

- 1) After adjustment and repair of a radiation preventing device, make a repair record for the measured values, and keep the data.
- 2) If the radiation leakage is more than $4\text{mW}/\text{cm}^2$ after determining that all parts are in good condition, functioning properly and the identical parts are replaced as listed in this manual notify that fact to ;

CENTRAL SERVICE CENTER

- 5-11-2 At least once a year have the microwave energy survey meter checked for accuracy by its manufacturer.

6. Troubleshooting

WARNING FOR HIGH VOLTAGE

4000 VOLTS EXIST AT THE HIGH VOLTAGE AREA. DO NOT OPERATE THE OVEN WITH CABINET PARTS REMOVED. DO NOT REMOVE THE CABINET PARTS IF THE POWER SUPPLY CORD IS PLUGGED IN THE WALL OUTLET. UNPLUG THE POWER CORD BEFORE SERVICING.

6-1 Electrical Malfunction

Parts	Cause	Diagnosis	Remedy
Fuse blows out when door is opened.	Defective primary interlock switch ary winding.	Check continuity of the primary switch terminals with wire removed using a multimeter. If there is continuity between switch terminals when door is opened, the switch is defective.	Replace the primary interlock switch
	Defective interlock monitor switch	Check continuity of the monitor switch terminals with wire removed by using a multimeter. If there is continuity between switch terminals when the door is closed, the switch is defective.	Replace the interlock monitor switch
Fuse is open.	Layer short of the secondary coil of H. V. Transformer	The fuse will not blow right away, but if it blows in a few seconds, then there is a layer short. If the fuse blows with H. V. Trans secondary open, the transformer may be faulty.	Replace H. V. Transformer
Oven lamp does not light.	1) Fuse blown out	Check fuse.	Replace the fuse.
	2) Poor contact of power cord	Check continuity of power supply cord. Also check whether the power cord is securely wired.	Adjust or replace the power supply cord.
	3) Defective lamp	The fan motor rotates, but lamp does not light.	Replace the lamp.
	4) Defective timer contacts	Check the terminals of timer for continuity, turning the timer knob ON and OFF repeatedly.	Replace the timer.
	5) Thermal cutout S/W open	In this case the oven lamp and fan do not turn on	Replace the thermal cutout S/W
Fan does not operate.	1) Defective fan motor.	If 220~230V is found at motor terminals, the motor should be replaced.	Replace the motor.
	2) Defective contacts of timer	The oven lamp does not light and fan motor does not operate.	Replace the timer.

NOTE: Interlock monitor switch must be replaced when the fuse is blown out.

6-1 Electrical Malfunction (Continued)

Parts	Cause	Diagnosis	Remedy
Microwave turns off during cooking cycle.	1) Too small a load	If a small amount of food is heated for a long time, period of microwave may turn off during operation.	To increase the oven load, add a glass of water into the oven.
	2) Defective magnetron thermal cutout S/W	Check to see if the magnetron thermal cutout switch is activated at a temperature higher than 150°C.	Replace thermal cutout switch.
Electric shock is felt.	Incomplete grounding	Make sure that grounding of the power supply cord has been done properly.	Rewire.
Door does not operate properly	1) Broken door hinges	Remove the cabinet for inspection. Check the door hinge.	Replace door hinges.
	2) Missing or loose screw	Check if the screws are secured well to the door hinge.	Fasten or tighten.
Timer does not operate.	1) Defective timer motor	If the timer does not operate with 220~230V applied to the terminals, the timer motor may be faulty.	Replace timer.
	2) Defective contacts of timer S/W	The lamp does not light.	Replace timer
Cooking tray does not rotate.	1) Defective drive motor	Check to see if 220~230V exists at the motor terminals. If so, motor will be defective.	Replace drive motor.
	1) Blocking of the ventilator	Check if the air inlet or outlet ventilation is blocked by the wall or other objects.	Keep a distance of 100mm from the wall or the objects.
Magnetron thermal cutout switch OFF	2) Defective fan motor	If the fan motor does not operate with 220~230V applied to the terminal, the motor may be faulty.	Replace fan motor.
	3) Too small a load or no load	If a small amount of food is heated repeatedly over a long period of time, microwave turns off during operation.	To increase the oven load, place a glass of water into the oven.

6-2 Unsatisfactory Cooking

Parts	Cause	Diagnosis	Remedy
Food is not heated.	1) Open cathode of magnetron	Check the terminals with a multimeter to see if the heater circuit is open.	Replace magnetron.
	2) Defective H. V. Diode	Check the H. V. Diode for continuity in the reverse and normal directions using megger. If there is continuity in the reverse direction, the H. V. Diode may be faulty. (In this event H. V. Capacitor will be hot)	Replace H. V. Diode.
	3) Shorted magnetron	Connect megger leads to quick-connect terminal & body of the magnetron if there is continuity, the magnetron may be faulty. (In this case the main fuse will be blown)	Replace magnetron.
	4) Defective magnetron	If there is a crack in the magnetron antenna (dome), the magnetron is defective.	Replace magnetron.
	5) Poor contact of primary interlock switch	Check if the screws are secured well to the door hinge. and pressing it ON and OFF repeatedly.	Replace or adjust.
	6) Open coil of H. V. Transformer	Check the continuity of primary coil and secondary coil. If there is no continuity, H. V. Transformer is defective.	Replace the H. V. Transformer.
	7) Shorted H. V. capacitor	Check the continuity of capacitor. If the capacitor shorts, the fuse blows	Replace the H. V. Capacitor.
	8) Monitor fuse blown out	Check the monitor fuse (on the noise filter)	Replace the Monitor fuse

6-3 Part Check List

Symptom	Related Parts	Check Points	Remedy
Microwave cooking does not work.	H.V.Transformer	1) Check if the primary and secondary coil is open or shorted. * Resistance of primary coil: Approx. 2.30 Ω Resistance of secondary coil: Approx. 123 Ω 2) Check if the MGT Heater Voltage is approx. 3.3V AC. Caution : High voltage !	Replace.
	H.V.Capacitor	Check continuity of capacitor between two terminals with H.V.wire lead removed. The resistance should be approx. 10M Ω , it's failure.	Replace.
	H.V.Diode	1) If there is no continuity in forward, direction the H.V.Diode is open. 2) If there is continuity in reverse direction, it's shorted.	Replace.
Fan motor does not rotate.	Fan motor	Check if the motor coil is open.	Replace.

7. Exploded Views and Parts List

7-1 Main Exploded View

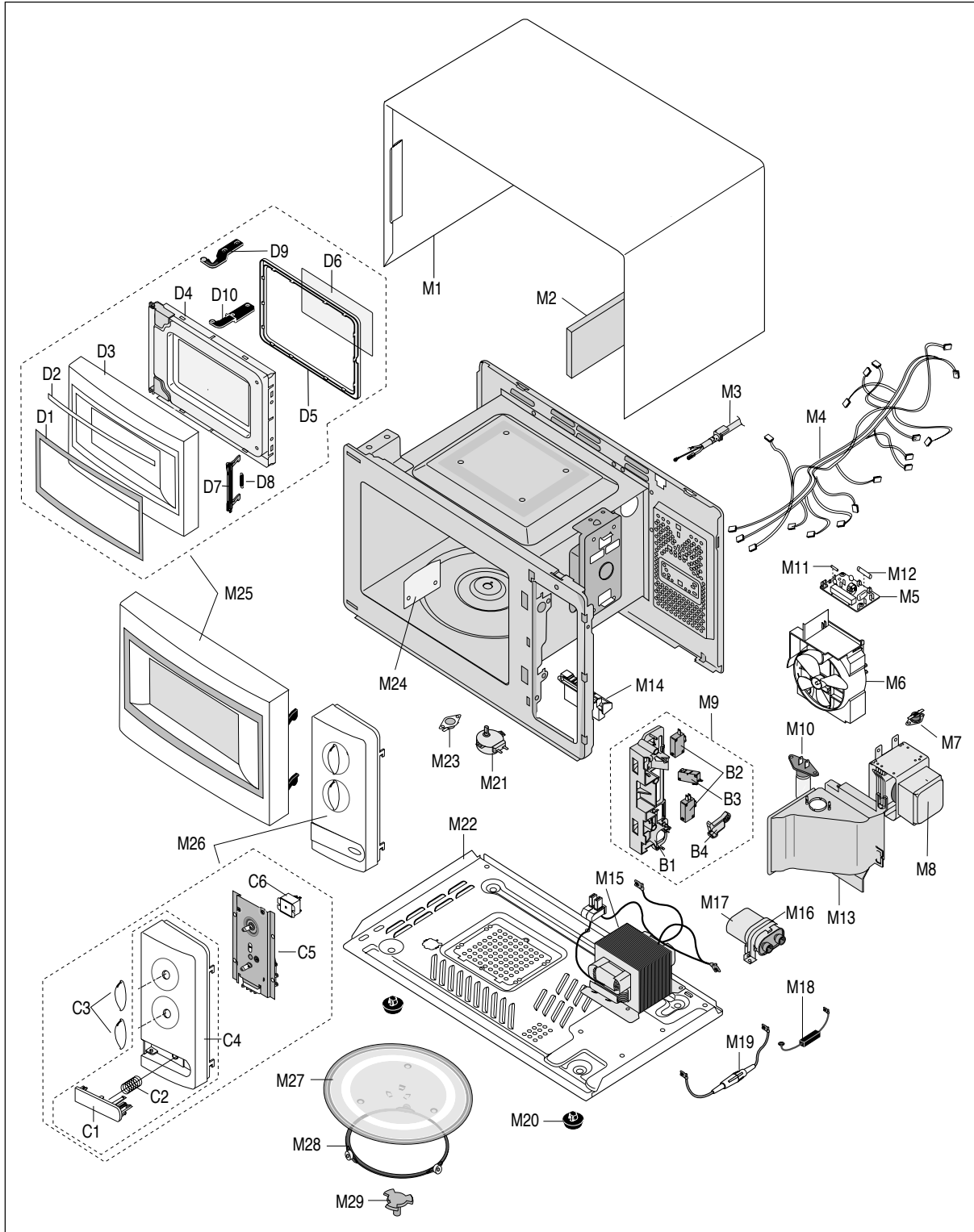

7-2 Main Parts List

Ref. No.	Parts No.	Description	Specification	Q'ty	Remarks
M 1	DE70-30116B	PANEL-OUTER	SECC,T0.6,W351.7,L1014.7,WHT-C	1	
M 2	DE63-90035G	CUSHION-RUBBER	DFA20,T2,W190,L100,BLK	1	PN/OUT
M 3	DE39-20075A	ASSY POWER CORD	UD13A1,240V16A,L1500,0.75MM	1	
M 4	DE39-40539A	WIRE HARNESS-A	230V50HZ,M935	1	
M 5	DE91-40095A	ASSY NOISE FILTER	SN-E10D(N),250V,10A,2ND-WD-TYP	1	
M 6	DE31-30031A	FAN-MOTOR	SMF745EA,230V/50HZ,ASSY-FAN-MO	1	
M 7	DE47-20009A	THERMOSTAT	PW2N-520PB,160/60,250V/7.5A,H,	1	MG-TCO
M 8	OM75SH(31)ESS	MAGNETRON	-	1	⚠
M 9	DE93-20001A	ASSY BODY LATCH	2ND-W1,M97G45/M9745	1	
M10	4713-001004	LAMP-INCANDESCENT	230V,-,40W,ORG,-,25x71mm	1	CV/AIR
M11	3601-000448	FUSE-FERRULE	250V,10A,SLOW-BLOW,CERAMIC,6.3	1	
M12	3601-001126	FUSE-FERRULE	250V,1.6A,QUICK-ACTING,CERAMIC	1	
M13	DE71-60010A	COVER-AIR	PP(TB53),T1.7,WHT,64G,M745	1	
M14	DE66-90013A	LEVER-DOOR	POM(F20-01),NTR,MW5630T	1	
M15	DE26-10121B	TRANS-H.V	SHV-745EC1,230V,50HZ,KEC,2230V	1	⚠
M16	DE61-50106A	BRACKET-HVC	SECC,T0.8,W31,L125.8	1	
M17	2501-001105	C-OIL	950nF,2.1KV,BK,54x35x80,20	1	
M18	DE91-70063A	ASSY-HVD	V2M6,PI9.0,0.05MT	1	
M19	DE91-70061B	ASSY-H.V.FUSE	THV060T-0750-H,5KV0.75A,RED	1	
M20	DE61-40017A	FOOT	PP(A353),BLK,MW5630T	2	
M21	DE31-10154A	MOTOR-DRIVE	M2HJ49ZR02,ST-16,50/60HZ	1	
M22	DE80-10003A	BASE-PLATE	SGCC1-Z,T0.8,W340,L550,M745	1	
M23	DE47-20033A	THERMOSTAT	PW-2N,80/70,125V15A/250V7.5A,1	1	CV-TCO
M24	DE71-60011A	COVER-MGT	PP,T2.0,WHT,M745	1	
M25	DE92-40170D	ASSY DOOR	BUTTON,WHT,M633/M643,WHT/BASIC	1	⚠
M26	DE93-30365B	ASSY CONTROL-BOX	M633(SAW)	1	⚠
M27	DE74-20102B	TRAY-COOKING	GLASS,T5.0,PI288,780G,M745	1	
M28	DE92-90436A	ASSY-GUIDE ROLLER	D16.5,MW4370W	1	
M29	DE67-60002A	COUPLER	PPS,5GR,BRN,M97G45	1	

⚠ : Warning

● : Option Parts

⚠ : Electrostatically Sensitive Devices

7-3 Assembly Door Parts List

Ref. No.	Parts No.	Description	Specification	Q'ty	Remarks
D 1	DE67-20158C	SCREEN-DOOR	ACRYL,T1.5,W372.5,L197.8,WHT,M	1	▲
D 2	DE02-00125A	TAPE-DOUBLE FACE	ACRYL,T0.45,W9,WHT,WF103,#4420	1	DOOR/A
D 3	DE64-40252A	DOOR-A	ABS,T2.5,W402,L258,WHT,G643C	1	
D 4	DE92-50126D	ASSY DOOR-E	M745,-,BLK,ASSY PURCHASING	1	
D 5	DE64-40008B	DOOR-C	PP,T1.5,BLK,CE745G	1	
D 6	DE01-00003A	FILM-DOOR	PE-FILM,T0.15,W142,L262,M745	1	
D 7	DE64-40006A	DOOR-KEY	POM(TC3005),T2.0,12GR,BLK,CE94	1	
D 8	DE61-70033A	SPRING-KEY	ES,HSWR10,PI0.6,D6.0,L22.3,BLU	1	
D 9	DE61-80005A	HINGE-UPPER	SCP1,T2.3,ZN-COATIN,M745	1	
D10	DE61-80004A	HINGE-LOWER	SCP1,T2.3,ZN-COATING,M745	1	

7-4 Assembly Control Box Parts List

Ref. No.	Parts No.	Description	Specification	Q'ty	Remarks
C 1	DE66-20171A	BUTTON-PUSH	ABS,WHT,G643C	1	
C 2	DE61-70076A	SPRING-BUTTON	HSWR,PI0.6	1	
C 3	DE64-10122A	KNOB	ABS,WHT,5G,G633C	2	
C 4	DE72-70165A	CONTROL-PANEL	ABS,180G,WHT,T2.5,107.5,261,M6	1	
C 5	DE45-10074A	TIMER-ASSY	TMFK60MTA1,220/240V-50HZ,CMO-T	1	
C 6	3501-000309	RELAY-POWER	240V,3750VA,15A,-,6mS,20mS	1	TIMER
C 7	DE93-30563A	ASSY CONTROL-PANEL	M633(SAW)	1	

7-5 Assembly Body Latch Parts List

Ref. No.	Parts No.	Description	Specification	Q'ty	Remarks
B 1	DE66-40001A	LATCH-BODY	POM(F20-02),40GR,NTR	1	
B 2	3405-000178	SWITCH-MICRO	250V,15A,200gf,SPST-NO	2	
B 3	3405-000175	SWITCH-MICRO	250V,15A,200gf,SPST-NO	1	
B 4	DE66-90001A	LEVER-SWITCH	P.O.M(F20-02),2,6,NTR,2ND-W-P/	1	

7-5 Standard Parts List

Parts No.	Description	Specification	Q'ty	Remarks
DE60-10012A	SCREW-TAP TITE	TH,+,3,M4,L10,SWR10,ZPC2,TOOTH	1	N-F-EA
DE60-10012A	SCREW-TAP TITE	TH,+,3,M4,L10,SWR10,ZPC2,TOOTH	1	P-C-EA
DE60-10080A	SCREW-WASHER	M5,L12,2S	4	MGT
DE60-10080A	SCREW-WASHER	M5,L12,2S	4	TNS-HV
DE60-10082H	SCREW-A	2S-4X12,TOOTHED	2	B-PLTE
DE60-10082H	SCREW-A	2S-4X12,TOOTHED,	2	BD-LAT
DE60-10082H	SCREW-A	2S-4X12,TOOTHED	2	CN-BOX
DE60-10082H	SCREW-A	2S-4X12,TOOTHED	1	CV/AIR
DE60-10082H	SCREW-A	2S-4X12,TOOTHED	2	MO/FAN
DE60-10082H	SCREW-A	2S-4X12,TOOTHED	5	PN/OUT
DE60-10098A	SCREW-ASSY TAP TITE	PH,TC,M4X8,SWRCH18A,ZPC2,GLD,W	1	CV-TCO
DE60-10098A	SCREW-ASSY TAP TITE	PH,TC,M4X8,SWRCH18A,ZPC2,GLD,W	2	M/DRIV
DE60-10098A	SCREW-ASSY TAP TITE	PH,TC,M4X8,SWRCH18A,ZPC2,GLD,W	2	MG-TCO
DE60-20063A	BOLT-FLANGE	M4,10,ZPC3,YEL,MSWR	2	HI-LOW
DE60-20063A	BOLT-FLANGE	M4,10,ZPC3,YEL,MSWR	2	HI-UPP
DE60-10012A	SCREW-TAP TITE	TH,+,3,M4,L10,SWR10,ZPC2,TOOTH	1	-
DE60-10033A	SCREW-TH	TH,+,M4,L10,MSWR10,FEFZY	1	P/RELY
DE60-10069A	SCREW-TAP TH	TH,M4,L10,FRFZY	4	TIMER

8. Wiring Diagram

Wiring Diagram

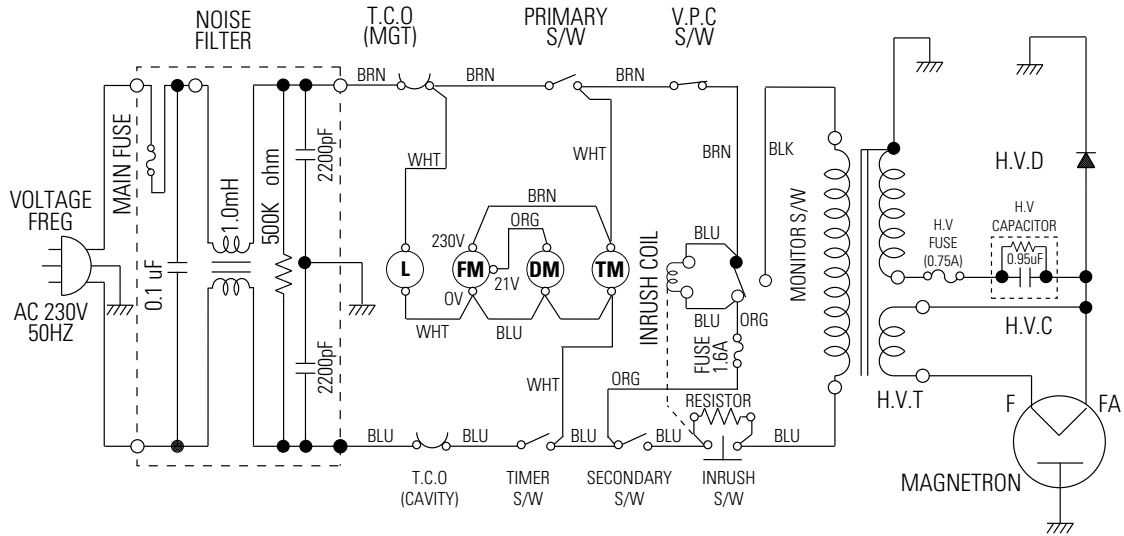

NOTE

DOOR IS OPENS	
BRN	BROWN
BLU	BLUE
ORG	ORANGE
WHT	WHITE
BLK	BLACK

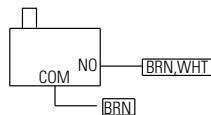

PRIMARY LATCH S/W

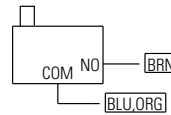

SECONDARY LATCH S/W

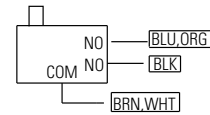

MONITOR LATCH S/W

High Voltage Circuit

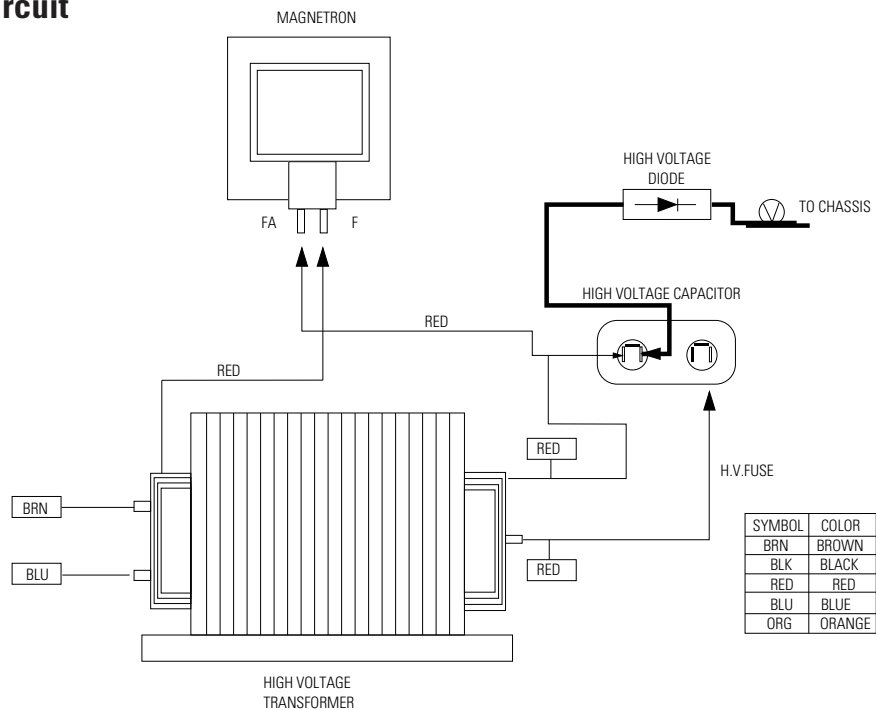

SYMBOL	COLOR
BRN	BROWN
BLK	BLACK
RED	RED
BLU	BLUE
ORG	ORANGE